

Varenummer: 40600801812460

Beskrivelse: Tandhjulsgeær C802F-18,1-P180B5

Mål

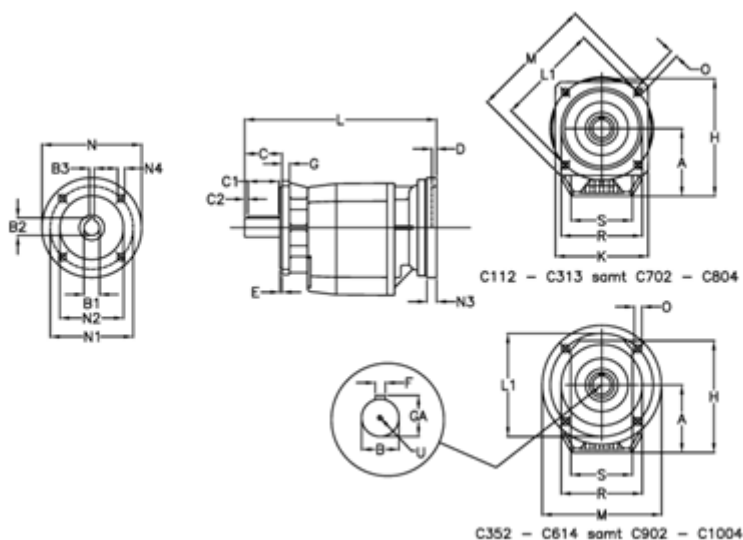

A = 247.0	D = 6.0	L1 = 350	R = 320
B = 80	E = 5	M = 400	S = 300
B1 = 48	F = 22	N = 350	U = M20x42
B2 = 51.8	G = 20	N1 = 300	
B3 = 14	GA = 85.0	N2 = 250	
C = 140	H = 422.0	N3 = 23	
C1 = 110	K = 350	N4 = 18	
C2 = 15	L = 635.0	O = 18.0	